

Winter 1980-81

OHIO SCIENTIFIC  
**Microcomputers**  
For Business,  
Industry and Science.

# Ohio Scientific Microcomputers for all reasons

Ohio Scientific has been building microcomputers longer than any company currently in the personal computer and small business computer marketplace. The company features a uniquely broad line of computer systems and interchangeable accessories. Ohio Scientific computer models range from the \$279 Superboard II which is the lowest cost complete computer on the market to the world's most powerful microcomputer; the C3-B GT which features a 74 million byte, 10 millisecond access disk and a 300 nanosecond instruction cycle processor. Ohio Scientific computer products are sold and supported by a world-wide network of over 350 computer dealers. The product line featured in this brochure is Ohio Scientific's professional series computers, software and accessories. All machines in this brochure incorporate dual 8" floppy disk drives and utilize the OSI 48 line BUS architecture of modular interchangeable PC cards. This architecture allows easy servicing, modification and upgrading. All machines in this brochure have internal firmware for instant disk loading and diagnostic testing and come complete with connecting cables, operating manuals and OS-65D disk operating system with extended BASIC so they can be utilized immediately when delivered by connection to a standard RS-232 terminal.

## Business

The most popular use of Ohio Scientific professional computers is in small business accounting. The minimum configuration of each computer has dual 8" floppies, 48K bytes of RAM and an RS-232 port making each computer usable in business applications as delivered. All Ohio Scientific machines can operate as single-user, stand alone computers, but by simply adding one PC board, they can also be used as intelligent terminals in a distributed processing network. Business software includes an advanced BASIC operating system; OS-65U which features end user operating ease and security as well as highly advanced file structures and communications protocols. OS-65U is unique in that programs written in this operating language are immediately upward com-

patible from single-user floppy systems to multi-user timeshare and/or distributed processing networks with hundreds of megabytes of hard disk. Specific business applications software include a complete word processor for use on any professional series computer (WP-2), a family of conventional fully integrated accounting systems (OS-AMCAP) and a highly advanced data base manager and information management system (OS-DMS). DMS based applications modules range from simple general accounting packages to Construction Quotation, Medical and Legal billing systems in stand alone and/or integrated single-user, multi-user and network compatible configurations. The data base structure of

further provides a wide range of language capabilities including BASIC, FORTRAN, COBOL, PASCAL, APL, FORTH, ALGOL and others. Ohio Scientific's broad range of compatible accessories include a solderless interface prototyping board, a high speed analog I/O module and a PROM blaster for use in hardware labs. OSI's home security and control I/O, unique voice I/O, and new telephone interface coupled with the fast access high capacity CD-74 hard disk provide unique opportunities for advanced computer science investigations on an educational budget.

## Research and Development

The C2 and C3 series computers feature the most advanced 6500 family operating system and architecture complemented by a fast resident interactive assembler/editor, on-line debugger and optional PROM blaster capability. The C3 extends this development system capabilities to the 6800 and Z80 family by nature of its three-processor architecture. Ohio Scientific's broad range of plug compatible accessories include a unique voice recognition breadboard, a powerful Votrax<sup>®</sup> based voice output system, a general purpose telephone interface, a fast analog I/O module, very

fast high storage capacity hard disks, and computer network capabilities. These leading edge technology products provide opportunities for advanced architectural investigations and development without extensive hardware modifications. To further enhance the C3's usefulness in R/D applications, the company is currently developing a 68000/Z8000 CPU expander board which is designed to plug-in to existing C3 series computer systems.

## OEM

Ohio Scientific's broad line of plug-compatible products and mass production economies provide a tremendous cost/performance benefit to both original equipment manufacturers and "systems houses". Contact your local dealer or the factory for OEM contract details on computers, accessories, complete systems and/or subassemblies.

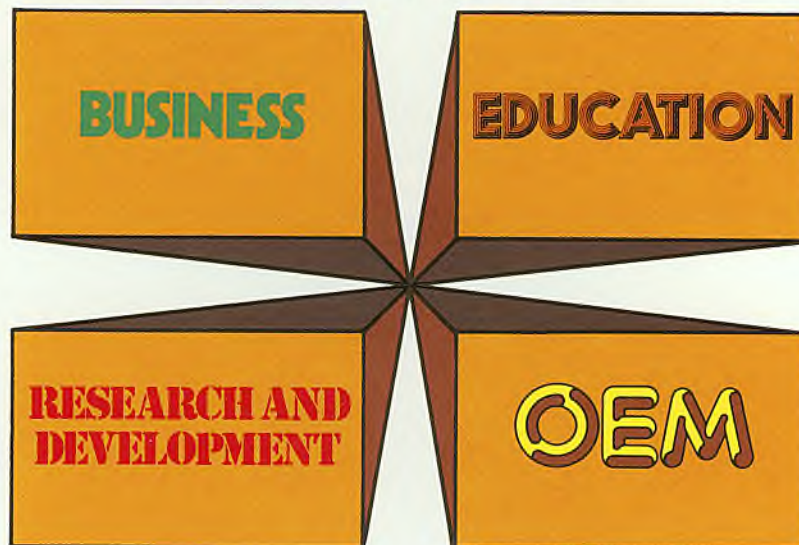

these packages allows a high degree of end user customization without programming through use of powerful general purpose report writers, mathematical packages and an on-line query facility.

## Education

Ohio Scientific personal computers are very popular in general education. The professional series offers capabilities for advanced educational use. Ohio Scientific's C1P and C4P series computers can be connected to a C2 or C3 computer to utilize its floppy disk and printer, and to allow teacher monitoring and communications under OS-65U Level 1 operating system. The Challenger III's unique three-processor architecture provides opportunities for students to compare architecture, machine code, assemblers and upper level languages for three types of processors on one machine. OS-CP/M

# C2-OEM



The C2-OEM with cover off showing the placement of floppy drives, UL recognized power supplies and 8-slot OSI 48 BUS backplane.

Ohio Scientific's new C2-OEM is designed to be the cost effective solution to business and industrial applications which can effectively utilize typical microcomputer execution speed. The C2-OEM benefits from Ohio Scientific's years of volume microcomputer production experience yielding an extremely competitively priced medium performance microcomputer.

The C2-OEM utilizes the popular 6502 microprocessor operated at 1MHz clock speed in conjunction with 48K or 450 NS Dynamic RAM memory.

This hardware configuration when used in conjunction with Ohio Scientific's ultra fast BASIC by Microsoft yields Business environment performance equal to or better than competitive microcomputer systems.

The C2-OEM is housed in a versatile table top cabinet which can also be rack mounted or incorporated in a matching desk which also accommodates a CRT terminal and printer.

The system features very simple physical construction and the use of industry standard parts for reliable operation and simple servicing. All circuitry is on two 8 x 10" OSI BUS compatible PC cards, one for the 48K memory and the other which contains the CPU, Firmware, RS-232 port and floppy controller.

The cards are plugged into an 8 slot back plane which provides tremendous expansion capability. The unit features two industry standard 8" Floppy disk drives and is powered by two standard UL recognized open frame power supplies.

The C2-OEM's low cost, simple construction, standard performance, and factory configuration make it the logical choice when a simple, rugged "no problems" computer is desired.

## Features:

Simplest, most cost-effective computer when typical microcomputer execution speed is acceptable.

- Full business configuration standard • 48K dynamic RAM
- .35 MIPS 6502 CPU • RS-232 port at 300 to 19,200 baud
- Dual 8" floppies store 600 Kbytes
- OSI BUS oriented for modular expansion
- Fast low overhead disk operating system standard
- Microsoft BASIC with random and sequential access files
- Instant load disk bootstrap and front panel emulator in ROM
- UCSD PASCAL and FORTRAN available

## Prices

C2-OEM As specified above **\$2950**

## Options

- 01 Double-sided disks doubles capacity to 1.2 Mbytes. **800**
- 02 Internal video board and keyboard with numeric pad provide complete terminal function with upper/lower case and graphics within the computer (a low cost alternative to conventional CRT terminals). Just add a TV monitor for a complete low cost system. **299**
- 03 Conversion to static RAM uses one more slot (2-24K boards) and adds 4.5 amps additional power. **700**  
Now includes 2 MHz operation.

- 04 Double cases—uses separate cases for computer and floppies. **200**
- 06 OS-AMCAP package provides AMCAP V1.5 and OS-65U at a \$300 savings when purchased with the computer. **\$775**

## Notable Accessories

- AC-3P 12" TV monitor for use with the 02 option **\$149**
- CA-17 Plug-in board adds intelligent terminal capability under Level 3 NET. **298**
- DSK-5A 5 foot matching desk with slide-in mounting for C2-OEM, C3-OEM or C2-NET. **300**

## Custom Desk DSK-5A



## Special System

C2-NET C2-OEM-04 with a CA-17 but without the floppy disk drives. Unit has special "down load" bootstrap ROM which loads the operating system from a network data base on power up. Just add on RS-232 terminal for the lowest cost intelligent terminal configuration. **\$1699**

# Ohio Scientific Microcomputers for all reasons

## The Premium Performance C3 Series

The Challenger III family of computers is one of the most popular small computers in existence with tens of thousands of units installed to date. The C3 series provides several unique features including:

- 3 processors — the 6502A, 68B00 and Z80A
- User programmable interrupt vectors on all three processors
- OSI 48 line BUS architecture with 16 data lines and 20 address bits (1024K address space)
- Upward expandability to 74 megabyte disk drives
- Upward expandability to timeshare and distributed processing configurations
- Broadest line of plug compatible accessories in the industry
- Broadest line of systems and applications software of any small computer (three processors is unbeatable here)
- Fastest instruction execution speed commercially available in a microcomputer (with GT option)

The C3's Z80 supports Ohio Scientific's implementation of Digital Research's CP/M® operating system. This very popular operating system supports nearly a dozen upper level languages and hundreds of business, scientific and educational packages from several independent suppliers. The Challenger III's 4MHz Z80A processor, fast stepping rate floppies and large disk buffer size make it one of the fastest CP/M operating system compatible computers available.

CP/M's excellent performance is overshadowed by the C3's 6502A ultra-high performance processor which executes Ohio Scientific's OS-65D developmental operating system and OS-65U, a highly advanced business BASIC operating system with multi-user and distributed processing capabilities. The 6502A performs a memory to accumulator ADD in 1.0  $\mu$ s. and a jump extended in 1.5  $\mu$ s. with an overall average of .7 Million Instructions per Second (M.I.P.S.) making it far faster than any other widely used microprocessor (including the new 16-bit versions).

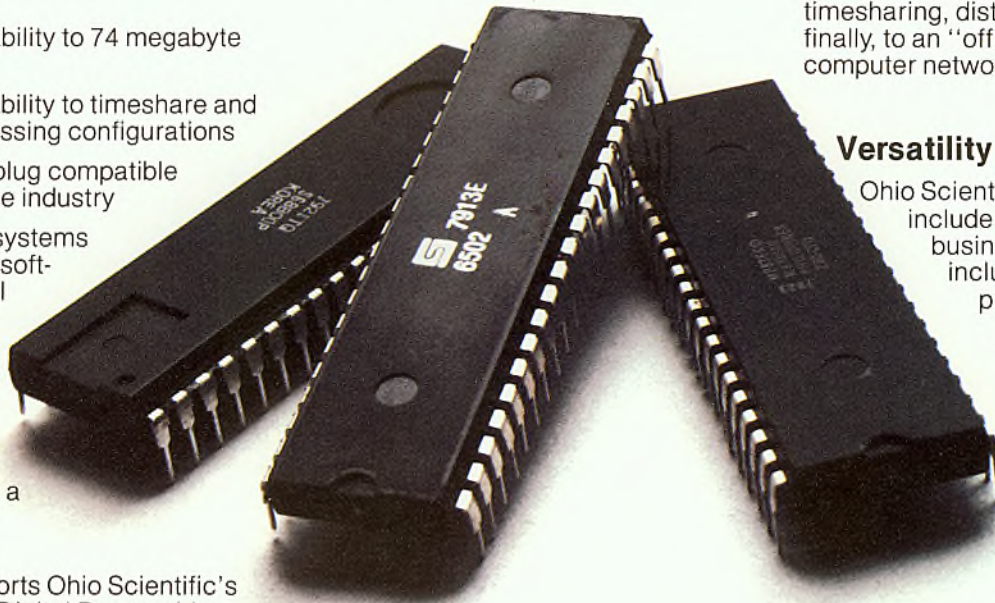

The GT option further extends Challenger III performance by utilizing the 6502C processor and high speed static RAM (150 ns. access) to achieve memory to accumulator ADD of 600 ns. and 1.2 MIPS average operation. This performance level places the C3 GT models comparable to mid-range minicomputers (\$50,000 to \$100,000 price range) in typical business and other information

intensive applications. Such computers are much faster in arithmetic operations because of their wider wordwidth but this performance advantage is not cost effective in all but the most demanding number crunching applications.

## Upward Expandability

Users can start with a relatively modest C3-OEM table-top computer and transport all of their software and most, if not all, of their hardware upward in simple plug-together expansion steps to hard disk storage, multi-programming — timesharing, distributed processing and finally, to an "office of the future" computer network.

## Versatility

Ohio Scientific's plug-in options include the full scope of business accessories including a word processing printer, modem and matching furniture. Parallel I/O, A/D D/A capability, PROM blaster, clock and prototyping options satisfy the needs of the educator and OEM.

Voice I/O, the Universal Telephone Interface, AC remote control, wireless security systems, affordable ultra-fast execution speed, network capability and huge storage capacity challenge the most creative innovators to develop the applications of tomorrow.

# The Challenger III Series



**C3-OEM**

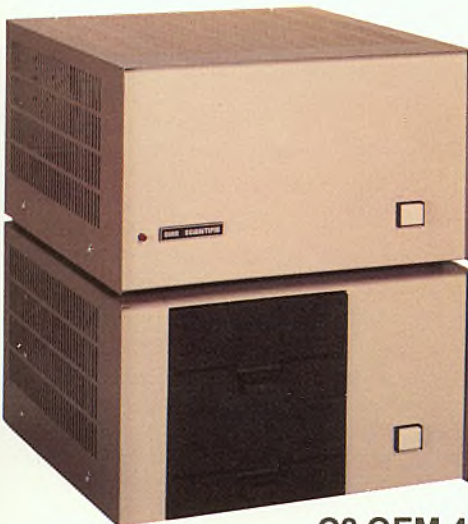

**C3-OEM-4**



**C3-A**

## Family Features

Premium performance 3-processor computer systems.

- Full business configuration standard
- 3-processors 6502A, 68B00, Z80A
- 6502A operation at .7 MIPS standard
- Z80A operation 4MHz, 68B00 operation 2MHz
- 48K high speed static RAM standard
- 20 address bits with memory pager addresses 768K
- User programmable interrupt vectors
- 8-bit parallel I/O port
- Instant loading floppy disk bootstrap/hard disk bootstrap/front panel emulator in ROM
- RS-232 port strappable from 300 to 19,200 baud
- Dual 8" floppies store 600K bytes
- OSI 48 line BUS oriented for modular expansion
- OS-65D fast low overhead development operating system with ultra-fast BASIC standard
- OS-65U advanced business operating system standard
- Largest accessory family in the micro-computer industry
- Largest software library in microcomputing (due to its unique 3-processor architecture)

## C3-OEM

These two computers are table-top versions of the C3 system with a total of eight OSI BUS slots. They are ideally suited to applications which do not require hard disk drives and/or multiple users. Both systems can be enhanced by adding the GT option and/or dual-sided drives. They support OS-CP/M by expansion to 56K RAM and can be networked by expansion to 56K and a network I/O port. (The CA-17 provides network and CP/M compatibility.) The C3-OEM is a single-case table-top unit similar to the C2-OEM except for larger power supplies and can be mounted in the DSK-5A. The C3-OEM-4 is in two cases which can be shipped via U.P.S. (the C3-OEM must be shipped by freight). The C3-OEM-4's floppies can be independently turned off; a useful feature for process control and security applications.

## Prices

C3-OEM	As specified above with 48K	<b>\$3995</b>
-GT Option	Increases execution speed to 1.2 MIPS average (150 ns main memory)	<b>1500</b>
-04 Option	Double cases — uses separate cases for computer and floppies.	<b>200</b>

## C3-A

The C3-A system is a 17-slot version of the C3 series in a stylish free-standing equipment rack. Although the standard machine has the same circuit boards and hence the same functional specifications as the C3-OEM, the system can be directly expanded to 8 users, hard disk operation and a network data base node configuration by simple plug-in operations. The rack also accommodates the PDS-1 system power sequencer and Alloy Engineering cartridge tape back-up units.

The C3-A features rack slide-mounted CPU and floppies as well as removable side panels and locking back door for convenient servicing and upgrading.

## Prices

C3-A	As specified above with 48K	<b>\$5995</b>
-GT Option	Increases 6502 execution speed to 1.2 MIPS	<b>1950</b>
CD-74	expands C3-A to C3-B	<b>8000</b>
CD-23	expands C3-A to C3-C	<b>5000</b>
CA-16	heavy duty cooling pack (specify B or C)	<b>150</b>

## C3 Family Options

-01	Double-sided drives, doubles capacity to 1.2 Mbytes	<b>\$800</b>
-06	OS-AMCAP package provides AMCAP 1.5 at a \$200 savings when purchased with the computer (65U is standard with C3's)	<b>775</b>
-07	CP/M package requires CM-10 or CA-17 for operation. Provides OS-CP/M, Z80 Assembler/Editor, Microsoft Z80 BASIC, FORTRAN and COBOL at a \$250 savings over individual prices when purchased with the computer.	<b>400</b>
-08	Real time clock option	<b>100</b>

# Ohio Scientific Microcomputers for all reasons

## Winchester Technology Disks

Floppy disks store from 250K bytes to 500K bytes per surface in a series of concentric circles called tracks which each store 2.5K to 7K bytes. To access specific information a head must be mechanically positioned over the track, then the computer must wait for the information to rotate under the head. On an 8" floppy accessing a specific piece of information this can take as long as 1.2 seconds even though the computer could have processed the information in a few microseconds. (The access time of minifloppies is much worse.) Furthermore, in most business applications, it is impossible to store all necessary information on one floppy disk; thus requiring several diskettes and frequent disk changes.

The traditional solution to these problems is the conventional removable platter hard disk. These disks rotate ten times faster than floppies and use more elaborate head positioners to move from track to track as much as ten times faster than floppies. Hard disk storage ranges from a few megabytes to a few hundred megabytes.

There are several problems with conventional hard disks. First and foremost, the extremely high bit density on the disks makes them very sensitive to mechanical misadjustments and contamination such as vibrations, dust and temperature differences of a few degrees, etc. Attempts to use removable hard disks in any other than a big computer, air conditioned, clean room environment by other than experienced computer operators can result in expensive head crashes and the complete loss of a disk pack. The second problem with these drives is that since they require close mechanical tolerances for bit density, disk removability and interchangeability, they are very complex mechanical devices. This results in large physical size, high power requirements and, most of all, high initial cost and high maintenance cost.

## Enter the Winchester:

In the mid-70's a new disk technology was developed which eliminates most of the undesirable features of hard disks for small computer users; the Winchester hard disk. Winchesters utilize fast rotating high density disks and medium to high speed head positioners

to achieve performance comparable to the most expensive hard disks. However, to minimize mechanical complexity and difficulty of use, they use fixed or non-removable media. Because the media is factory installed, the critical head-disk tolerances can be maintained with relatively simple mechanics. The fixed nature of the drive allows the disk chamber to be sealed eliminating the possibility of contamination.

Most Winchesters simply have an on-off switch making

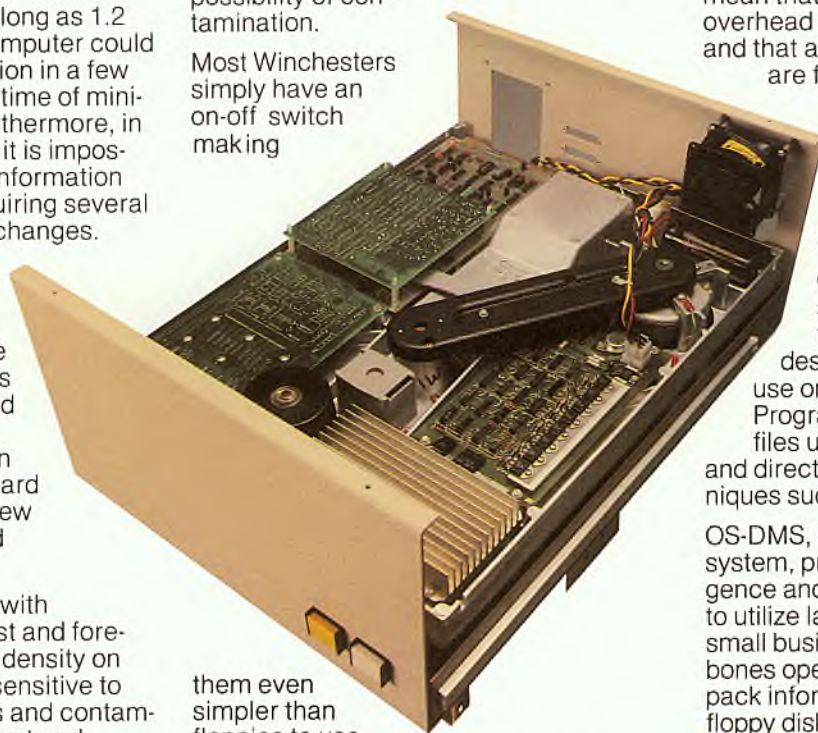

them even simpler than floppies to use from an operator viewpoint. In high storage capacity models they achieve the lowest cost per bit of any Random Access Memory technology now available.

The Winchester disk solves all the problems of floppies and conventional hard disks but creates one big new one! Back Up. Ohio Scientific has effectively solved this problem with three approaches depending on the specific application, see the box below.

## Ohio Scientific Winchesters

OSI pioneered the use of Winchesters with microcomputers in 1977. Since then, we have installed more units than anyone else and have developed the most sophisticated Winchester hardware and software products for microcomputer use.

## Hardware

Ohio Scientific offers two Winchester disks; the CD-23 and CD-74 (see next

page) although they use different disk drives, the basic architecture is the same. Both units use a dedicated but programmable hard disk controller which receives commands from the host processor and then performs disk transfers independent of the processor. Data transfers are to and from a large dual port memory buffer. The dual port architecture and stand alone disk controller mean that virtually no processor overhead is required for disk transfers and that all segments of disk transfers are fully interruptible. Thus, disk operation does not degrade terminal interrupt response time in multi-user systems, a very important feature.

## Software

OS-65U business operating systems and OS-DMS information management systems were designed from the "ground up" for use on Winchester based computers. Programs in 65U can directly access files up to 100 megabytes in length and directly support fast access techniques such as multi-key ISAM.

OS-DMS, information management system, provides a high degree of intelligence and end user versatility by its ability to utilize large disk files whereas most small business computers offer bare bones operation because of the need to pack information as tightly as possible on floppy disks.

Ohio Scientific Winchester disk based computers offer business users a dramatic improvement in total performance over floppy based micro and minicomputers at a relatively modest cost.

You now have three backup options for use with the C3-B and C3-C Winchester disk based computers:

1. Fast floppy dumper under OS-HDM for small files (5 Mbytes or less). Daily to weekly backup.
2. 3M tape backup unit from Alloy Engineering. About 11 Mbytes per tape, cost about \$3500. For medium files (Under 11 Mbytes). Weekly backup.
3. Networked C3-B's and/or C3-C's. Ultrafast backup of files up to disk capacity for Large files (over 11 Mbytes) and/or frequent backup requirements.

# Hard Disk Computers

C2-D



C3-D

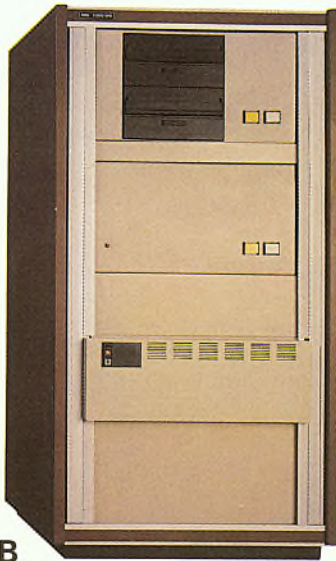

C3-B

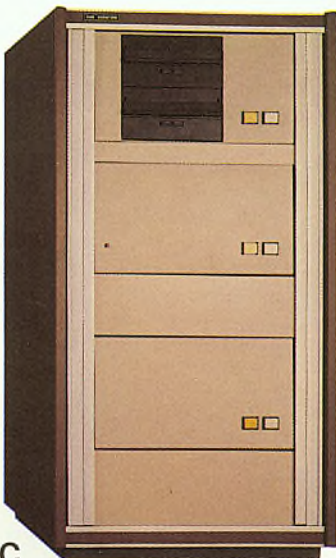

C3-C

## Family Features

- Highly advanced OS-65U operating system:
  - Multiple level pass word security
  - Multiple operating systems on disk
  - Ultra-high speed "FIND" command for high speed string searches (Associative Access)
  - Upward compatible with multi-user and network systems with full file, peripheral and communications arbitration between users.
- Expandable to CP/M operation by adding 4K (CM-2 memory)
- C3-B and C available factory configured for up to 8 users and network data base operation
- C3-B and C 17-slot OSI 48 line BUS architecture for large system expansion
- Comes standard with real time clock and heavy duty cooling package

## C2-D

The C2-D mates Ohio Scientific's low cost "work horse" C2-OEM micro-computer with an 8" 10 megabyte Winchester disk. This new ultra low cost table top system provides hard disk performance at floppy disk system prices. The C2-D comes complete with 52K RAM, a serial I/O port for console communications, bootstrap and diagnostic firmware, and a single 8" floppy disk drive for program transport and backup. The computer system comes complete with OS-65U. **\$6795**

## C3-D

The C3-D mates the electronics of the popular Challenger III triple processor microcomputer system with the cost effective 8" 10 megabyte Winchester disk. The C3-D incorporates 52K high speed static RAM, serial I/O port, bootstrap and diagnostic firmware, 8" floppy disk for transport and backup as well as an 8" Winchester. The C3-D comes complete with OS-65U. **\$7600**

## C3-B

The world's most powerful micro-computer (when GT equipped). Features the highly advanced and extensively field proven OKIDATA 3306 Winchester disk. Some 3306 drives have operated since 1977 without a single failure.

## Features

- System boots from floppies or hard disk on power up
- 74 megabytes end user workspace under OS-65U, 80 megabytes unformatted
- Ultra-high performance disk
  - 74 millisecc worst case access
  - 38 millisecc average
  - 10 millisecc access on cylinder (215K user workspace)
  - 8 megabits per second transfer rate
- Simple on/off disk operation with elaborate internal protection from improper temperature, line voltage and controller failures
- Features spindle brake and designated head landing areas for much longer operational life than the newer low-cost Winchesters

C3-B **\$13,995**  
 GT Option (as per C3-A) add **1,950**

## C3-C

A medium performance Winchester disk based system which provides the ideal cost/performance ratio in typical small business applications. The C3-C uses the Shugart SA4008 29 megabyte Winchester disk.

Performance specifications, hardware configuration and software is identical to the C3-B with the following exceptions:

- 23 megabytes of end user workspace under OS-65U
- 29 megabytes unformatted capacity
- Medium performance Winchester
  - 240 millisecc worst case access
  - 87 millisecc average access
  - 10 millisecc access on cylinder (110K user workspace)
- Simple on/off disk operation

C3-C **\$10,995**  
 GT Option (as per C3-A) add **1,950**

# Ohio Scientific Microcomputers for all reasons

## Multiple User Systems

In applications where several terminals are desired, but most of which will be utilized for entry and editing (such as order entry systems), multiple user microcomputers are feasible. In environments where it is commonplace for more than one user to be processing information at a time, a single microcomputer may become annoyingly slow. A better configuration for such applications is distributed processing as discussed later.

All C3 series computers will support up to 16 timeshare users under OS-65U Level 3 providing that the computer has a real time clock, sufficient memory and the appropriate communications ports.

C3 computers utilize bank switching for multiple users. Each user must have 32K to 48K RAM and an RS-232 port. The host machine must also have 4K RAM for the multi-tasking executive. The computer timeshares individuals by interrupting a user after a set time (approximately 100 milliseconds) and bank switches to the next user in a "round robin" fashion. Bank switching architecture is not as memory efficient as techniques which use re-entrant code or swapping disks but is by far the fastest technique, requiring only a few microseconds of processor overhead per switch, a feature which is most important in multiple user systems.

Although OS-65U Level 3 will support timesharing on any C3, it is only recommended on C3-B and C3-C computers. This is because of the desirability of 17 BUS slots for multiple user memory partitions and the dramatic performance advantages of Winchester disks over floppies.

## Networking

In a distributed processing system using OSI microcomputers as intelligent terminals (local systems) most of the work

load is handled locally. Overall system performance does not degrade under heavy job loads. Each local system performs entry, editing and execution while utilizing a central data base for disk storage, printer output, and other shared resources.

For more demanding applications it is desirable to have several data bases, each with its own collection of local systems. Such an inter-connected set of data bases is called a network. Each data base and its local intelligent and dumb terminals is called a cluster.



## Level 3 NET

OS-65U Level 3 NET supports this advanced networking and distributed processing capability as well as conventional single user operation and timesharing. Level 3 NET supports local clusters of intelligent microcomputer systems as well as dumb terminals for the purpose of utilizing a central Winchester disk data base and other shared resources. The system also has full communications capability with other Level 3 data bases providing full network capability.

Level 3 resides in each network data base. A subset system resides in each intelligent terminal. Each data base supports up to 16 intelligent systems and up to 16 dumb terminals. Level 3 also supports a real time clock, printer management, and other shared peripherals.

## Data Base Requirements

Minimal requirements for a Level 3 network data base are a C3-C or C3-B computer system with 23 or 74 megabytes respectively, console terminal, 88K bytes RAM and a CA-10X 16 port I/O board for network and cluster communications.

## Intelligent Terminal Requirements

Any Ohio Scientific 8" floppy based computer with 56K RAM and one data base communications port.

## Connections

Intelligent terminals and networked data bases are connected by low-cost cabling. Each link can be up to 10,000 feet long at a transfer rate of 500K bits per second, and will cost typically 30¢ a foot (plus installation).

## Syntax

Existing OS-65U based software can be directly installed on the network with only one statement change! Level 3 has the most elegantly simple programming syntax ever offered on a computer network.

File syntax is as follows:

DEV A,B, C,D	Local Floppies	} unchanged from single user and timeshare system
DEV E	Local Hard disks	
DEV K-Z	Specific network Data Bases	

Each of up to 8 open files per user can be from 8 separate origins. Specific file and shared peripheral contentions are handled by 256 network semaphores with the syntax Waite N  
Waite N, close

The network automatically prioritizes multiple resource requests and each user can specify a timeout on resource requests. Semaphores are automatically reset on errors and program completion providing the system with a high degree of automatic recovery.



# Time Sharing/Networking

## One Step at a Time

Best of all, Ohio Scientific users can develop distributed processing systems economically one step at a time. A user can start with a single user floppy system, add a hard disk, then timesharing, then a second Winchester data base for backup and, finally, cluster intelligent terminals to achieve a full network configuration.

## Level 3 Support Group Factory Configured Systems

Prices include OS-65U Level 1 but do not include 65U Level 3 or Level 3 NET. Machines with NET prefix have the specified number of users plus NETWORK data base node capability. The NETWORK partition can be used as an extra user through its diagnostic RS-232 port.

For example, a 4-user system with networking can be used as a 5-user system without networking.

Network systems have ports for 4 intelligent terminals (cluster ports) and 1 NET port.

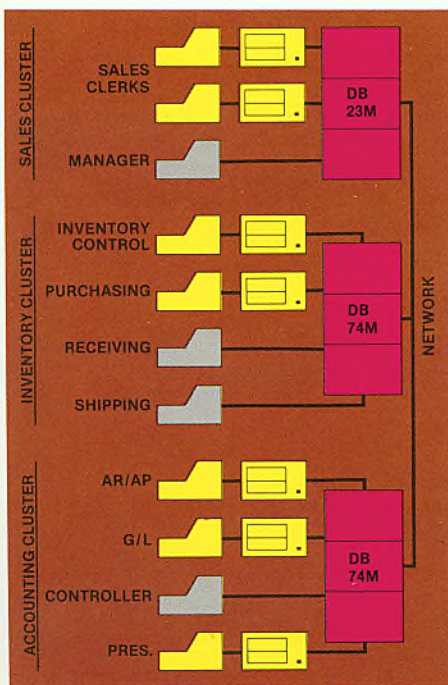

Time-share Users	C3-C .35 MIPS	C3-C .7 MIPS	C3-C .7 MIPS + NET	C3-B .35 MIPS	C3-B .7 MIPS	C3-B .7 MIPS + NET
1	NA	\$10,995 C3-C	\$12,995 C3-C-N1	NA	\$13,995 C3-B	\$15,995 C3-B-N1
2	\$11,900 C3-C-12	\$12,400 C3-C-22	\$13,995 C3-C-N2	\$14,900 C3-B-12	\$15,400 C3-B-22	\$16,995 C3-B-N2
3	\$12,700 C3-C-13	\$13,400 C3-C-33	\$14,995 C3-C-N3	\$15,700 C3-B-13	\$16,400 C3-B-33	\$17,995 C3-B-N3
4	\$13,400 C3-C-14	\$14,440 C3-C-44	\$16,200 <sup>1</sup> C3-C-N4	\$16,400 C3-B-14	\$17,400 C3-B-44	\$19,200 <sup>1</sup> C3-B-N4
5	\$14,100 C3-C-15	NA	NA	\$17,100 C3-B-15	NA	NA
6	\$14,800 C3-C-16	NA	NA	\$17,800 C3-B-16	NA	NA
7	\$15,500 C3-C-17	NA	NA	\$18,500 C3-B-17	NA	NA
8	\$16,200 C3-C-18	NA	NA	\$19,200 C3-B-18	NA	NA

Note 1. Uses 16-slots, 1 open, comes with printer and word processing ports installed.

# Ohio Scientific Accessories for all reasons



**AC-7B**  
CRT terminal for use on all OSI single and multi-user systems. Features upper/lower case 24x80 character display, numeric keypad, dual intensity, protected fields, cursor addressing and much more. **\$1095**



**AC-9TP**  
A rugged moderate performance business printer. Impact printing at 110 characters per second, prints 80 or 132 columns across the page, has adjustable width tractors and forms stacker. Comes complete with parallel interface and connecting cable. **\$1450**



**OSI Desks**  
**DSK-3** 3 foot wide CRT and printer stand. **\$175**

**DSK-4** 4 foot wide desk. **\$215**



**DSK-5** 5 foot wide desk. **\$250**

**DSK-5A** 5 foot desk with cutout and mounting brackets for C2-OEM, C2-NET and C3-OEM computers. **\$300**



**AC-14A**  
25 CPS Word Processing Printer. Includes a 96-character industry standard print wheel and a serial RS-232 interface. Direct connection to a C4P or C8P computer system. **\$1995**



**AC-5A**  
Deluxe business printer. This "Top of the line" shuttle printer very quietly prints an entire line at a time using dot matrix impact technology. The unit prints 160 lines per minute at a 132 character column width. Features upper and lower case, 12 programmable fonts, 11 program selectable form lengths and much more. Comes complete with adjustable width tractor-feed, high speed parallel interface and cable. **\$3350**



**DSK-6** 6 foot wide desk (best for CRT and printer). **\$285**

**AC-14B**  
45 CPS Word Processing Printer. Includes a 96-character industry standard print wheel and a parallel interface card. Requires a slot on the computer BUS. High speed makes this a perfect printer for C2-OEM or C3 computer systems **\$2795**



**AC-19**  
Low cost dot matrix printer with 40, 66, 80 or 132 columns, upper & lower case with descenders, bi-directional printing with logic seeking, auto line feed, vertical tab, form feed and horizontal tab. Requires CA-9 parallel interface or AC-19A serial card. **\$699**

**AC-19A**  
Serial adapter for AC-19 printer allows direct connection to C1P, C4P or C8P systems **\$75**



**AC-11P**  
300 baud modem for use with conventional telephone handsets. Features unique originate/answer back capability which allows two similarly equipped computers to talk to each other as well as communicating with timeshare services. Requires an RS-232 port for operation. **\$225**

# Microcomputer Components

## OSI Power Sequencers Turn Entire Systems On/Off From One Keyswitch.

**PDS-1** Switch panel for C3-A, B, C. Sequences CPU, floppies, hard disk, CRTs, printer and other accessories. **\$350**

**PDS-3** Switch panel for DKS-5A desk. Sequences CPU, floppies, CRT, printer and other accessories. **\$200**

**CM-9**

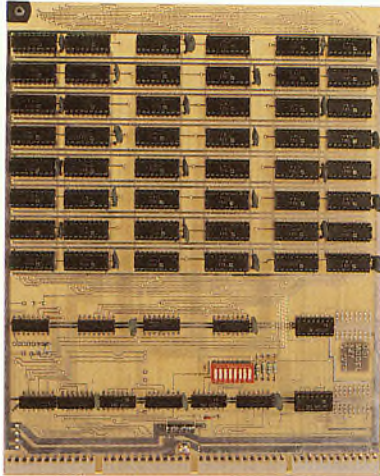

## Memories

**CM-2** 4K 2MHz static for expanding C3-B, C3-C to 56K for CP/M and/or networking. **\$129**

**CM-3A** 16K 2MHz low power static standard C3 memory. **\$399**

**CM-6** 48K 1MHz dynamic for C2-OEM and some timeshare systems. **\$549**

**CM-9** 24K 2MHz medium power statics usable in computer with booster supplies or high current switchers. **\$450**

**CM-10** 8K 2MHz static for expanding C2 and C3 computers to networking or CP/M. (C3 only) **\$198**

**CM-11** 48K ultra low power static memory for 2 MHz 6502 operation. Suitable for C4P, C8P, C2 expansion and C3 multi-user systems. **\$995**

**CA-10-16**

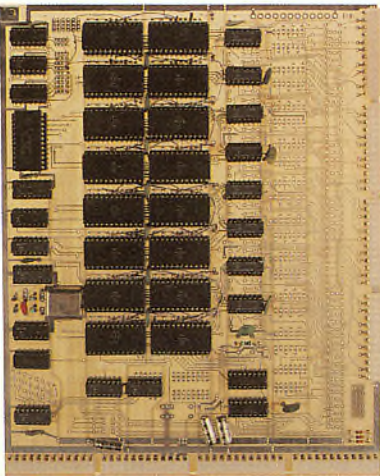

## General I/O

**CA-9** Centronics parallel printer interface with cable. **\$150**

**CA-9D** Diablo parallel interface with cable and connector for use with WP-2 or WP-3 and high performance word processing printers. **\$175**

**CA-10X** 1 to 16 RS-232 port I/O board. 300-19200 baud plus synchronous operation at 250K and 500K baud. 1 port standard. **\$125**  
Each additional port. **\$ 50**

**CA-10-N5** CA-10X port board configured for four cluster communications ports and one network communications port all at 500K baud for use in data bases. **\$349**

**CA-18A**

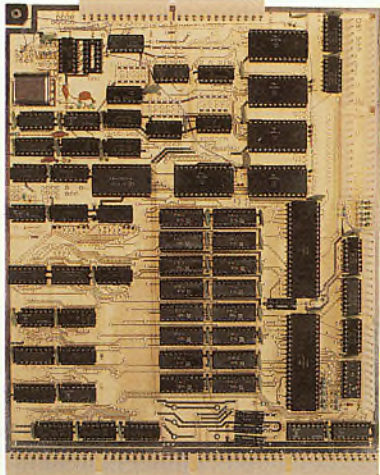

## Combinational I/O

**CA-17** 8K 2MHz RAM and 1 cluster port plus 1 auxiliary RS-232 port. (Converts any C2 or C3 to networking.) **\$298**

**CA-18** 1 Centronics parallel printer port with cable, 1 parallel word processing printer port with cable, 2 RS-232 ports and 1 cluster port. **\$398**

**CA-18A** As above with 8K 2MHz RAM and 2 additional RS-232 ports (4 total), i.e., fully populated 555. **\$598**

See the OEM and R/D section for more accessory boards.

# Ohio Scientific Software for all reasons

## OS-65D

OS-65D Version 3.2 is an easy-to-use disk operating system which fully supports Microsoft's 9-Digit Extended BASIC, a 6502 resident Assembler/Editor, 6502 Extended Machine Code Monitor and various I/O devices. The operating system is available for all Ohio Scientific mini-floppy and full size floppy disk configurations. The system is convenient for beginners to use via the programming language BASIC. It supports writing programs in BASIC, storing programs on disk, recalling programs and reading and writing sequential and random access data files in BASIC. The system also fully supports assembler language programming for the 6502. In conjunction with its assembler and machine code capabilities, it offers an extensive machine code debugging aid, the Extended Monitor. The system is also well suited to utilize machine code subroutines in conjunction with BASIC programs. It has advanced features such as variable sector length and its stand-alone disk operating system kernel can support other high level languages.

OS-65D and BASIC are included with all C2 and C3 series computers, the Extended Monitor and Assembler/Editor are extra.

OS-65D, with Extended Monitor and interactive Assembler/Editor for the 6502.

**\$75**

## WP-1B

WP-1B is an extended editor (with word processing features) combined with an interactive assembler for the 6502 and for the 6800. The system is useful for 6800 program development and of particular use in upper level software courses. It also includes a 6800 run time package.

WP-1B runs on any C3 series computer.

**\$150**

## Note:

Several personal, educational and entertainment programs originally developed for the C1P and C4P personal computers are now available for the C2 and C3 on 8" diskettes under OS-65D. Check with your dealer for current availabilities.

## OS-CP/M

OS-CP/M is Ohio Scientific's implementation of the Digital Research CP/M disk operating system and includes Microsoft 8080 Macro Assembler, Extended Disk BASIC, ANSI standard FORTRAN and ANSI standard COBOL. The CP/M system also includes a Text Editor, an 8080 Assembler and a Dynamic Debugger as well as various utility programs for file system maintenance.

This software system can be run on any Ohio Scientific C3 series computer with 48K of static RAM and 8K of static RAM at D000 to EFFF.

## OS-CP/M Version 1.4

Containing the latest versions of Microsoft software:

- COBOL Version 3.0
- FORTRAN Version 3.31
- MBASIC Version 4.51

**\$695**

OS-CP/M is maintained for Ohio Scientific by Lifeboat Associates, 2248 Broadway, Suite 321, NY, NY 10024, phone (212) 580-0022. Contact them directly for their latest CP/M compatible software catalog.

OS-CP/M II for large file storage on hard disks and a multi-user multi-programming version (MPM) are under development for use on the C3-B and C. Check with your dealer for availability.

## WP-3-2 Word Processor

This is an advanced word processor that is powerful yet easy for non-computer people to use. The new improved version 3 can be operated in either cursor or line editing modes. It includes commands that facilitate the entry of new text such as auto-line numbering, move text, resequence lines, merge and duplicate. Other features provide for ease of entering corrections— character insert and delete, back-space, type-over, search, search and replace, delete and insert lines. Formatted printouts can include automatic page numbering, justified or unjustified margins, proportional character spacing and automatic hyphenation. Commands can be embedded in the text to control indentation, line spacing, skip lines or to top of page and underline. Text is easily stored and retrieved from disk as named files which can be created, renamed, deleted, and listed by name. WP-3 supports the AC-14B Word Processing Printer. **\$300**



# Systems Software

## OS-65U

OS-65U is a 9-digit BASIC language system which includes a complete named file disk operating system for floppy disks and, for large capacity, hard surface disks. The file system supports both data and program files.

Data files appear to the user as a single contiguous block of data bytes that can be read or written sequentially or randomly. High speed file searches are possible with a special command that locates a specified character string.

Data file commands include OPEN, PRINT, INPUT, FIND, INDEX and CLOSE.

Program files hold BASIC programs in tokenized, ready-to-run form for higher execution speed.

Program file commands are LOAD, SAVE, RUN and LIST.

A common I/O distributor permits easy selection of any I/O device or combination of output devices.

OS-65U includes a timesharing executive program that provides file load, save and print functions up to 16 intelligent terminals (C4P's and C8P's). This educational system allows each of the 16 users to access floppy disk or hard disk storage for their BASIC programs and to share a central printer for hard copy listings. A Multi-Terminal Operations Manual is available from OSI.

OS-65U also includes a number of extensions to BASIC that provide complete systems programming capability to those who will be adding end-user oriented applications software. These extensions include programmer control of disk error action, comprehensive file access rights control, a "money mode" numerical output format and a BASIC statement trace to speed debugging.

Three levels of 65U operating systems are available.

### Level 1 (NMHz)

Ohio Scientific's virtual data file DOS and extended BASIC. Recommended for business applications. Now includes powerful BASIC program editor, ressequencer and word processing driver. Also automatically configures itself for 1, 2 or 3.3 MHz CPU speeds. Required for OS-DMS and OS-AMCAP. Level 1 also supports up to 16 C1P, C2P and C4P satellite computers. Specify CD-23, CD-74 or no hard disks. OS-65U is included with all C3 computers. **\$200**

### Level 3

Timesharing expansion (C3 only) allows up to 16 independent real time tasks to run concurrently (requires 32-48K additional memory per task partition). Includes shared resource support for disk files, printers, etc. **\$500**

### Level 3 NET

Network Extension permits interconnection of multiple hard disk based Level 3 timesharing systems (data bases) and Intelligent Terminals for program or data sharing. Shared resource support automatically expands throughout the network.

Network License—one year site license with 10 hours telephone maintenance and consultation support budgeted in a contract written directly between Ohio Scientific, Inc. and the end user. This software is delivered directly to the end user. **\$995**

### UCSD PASCAL AND FORTRAN \$450 (Configuration 3)

PASCAL is rapidly gaining acceptance second only to BASIC among small computer users. PASCAL's block structured programming organization is preferred by many educators as a means of teaching logical programming techniques. Furthermore, PASCAL's structure is considered by some to be more desirable than BASIC or FORTRAN for the rapid programming, debugging and maintenance of large programs. The system includes a powerful FORTRAN system based on a subset of the ANSI 77 standard. FORTRAN utilizes the same powerful screen editor and is compiled to the same "P" code. To complement the FORTRAN, PASCAL and Editor, a compatible assembler and run time linker is provided allowing machine code subroutines in either PASCAL or FORTRAN.

- UCSD PASCAL, FORTRAN, Screen Editor, Assembler and Linker for the 6502.
- Operates on standard 48K, dual floppy or dual mini-floppy configurations. No special memory or hardware features required.
- Executes twice as fast as competitive PASCAL based computer systems.
- Developed and maintained by Softec Microsystems, Inc.
- Uses OS-65D disk file formatting.
- Package includes PASCAL Primer and Operator's Manuals for PASCAL and FORTRAN.

## OS-65U

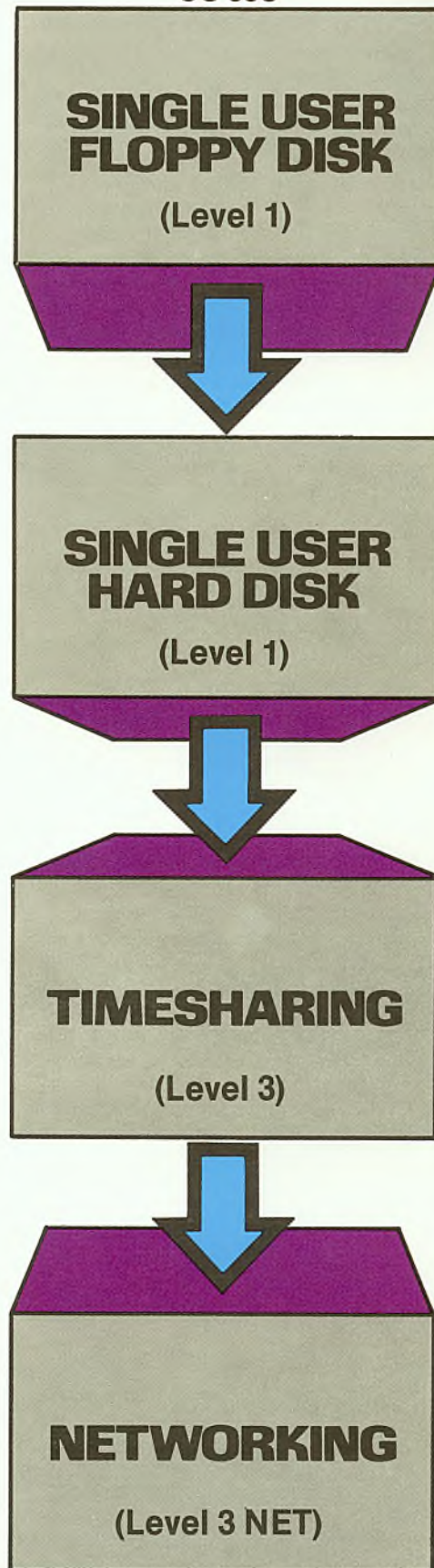

# Ohio Scientific Software for all reasons

## OS-AMCAP (Level 1.5)

OS-AMCAP is a fully integrated small business accounting system. The software package runs on any Ohio Scientific dual-floppy, double-sided dual-floppy or hard disk based 6502 system with at least 48K RAM. OS-AMCAP contains the following integrated modules using a common data base:

General Ledger, including a complete user defined chart of accounts, cash receipts, cash receipts journal, cash disbursements, cash disbursements journal, journal entries, editing, balance sheet, trial balance and statement of earnings with complete editing for all of the above.

Accounts Receivable with and without aging, aged monthly statements.

Accounts Payable with and without aging.

Inventory, including inventory analysis, inventory by vendor, inventory overdue, inventory on order, inventory re-order, and detailed reports.

Billing/Invoicing and order entry for the inventory which will optionally support customer files with bill to, ship to, credit and customer mailing and monthly statements.

Payroll

For easy installation, the AMCAP system includes the AMCAP configuration program which automatically creates all necessary disk files based on the user's requirements. An AMCAP training disk which is pre-loaded with information for a hypothetical company is also included for demonstration and training purposes. A 250-page AMCAP Level II manual is included that describes Levels 1.5 and II.

OS-AMCAP is designated by Ohio Scientific to be a small concise easy-to-use "turnkey" business software package. OS-AMCAP has been in use at hundreds of locations for over two years.

**OS-AMCAP \$975**

## OS-AMCAP Level II

OS-AMCAP Level II contains all of the features included in Level 1.5 in addition to many other significant and valuable expansions that are a direct result of many end user requests.

- Divisionalization and departmentalization in the general ledger, inventory and payroll and all accounting journals such as C/R, C/D, A/R, A/P, JE and aging reports, balance sheet and the statement of earnings.

- Multiple cash in bank accounts, multiple accounts receivable/payable accounts by division or department.
- Listing of general ledger journals by from-date-to-date.
- Enhanced order entry to include temporary inventory items, special discounts and special list price considerations in addition to credit memos and quotations.
- Enhanced payroll which allows for up to ten miscellaneous deductions and multi-state payroll withholding tax includes payroll 941 form, W2 forms and check registers plus an advanced employee file editor.
- Monthly statements contain inclusion of automatic overdue charges as a service charge on each statement which is ready for window envelope mailing.
- Preset IBM compatible system 32 and IBM system 34 forms for monthly statements, invoices and payroll checks that are available locally.
- OS-AMCAP Level II is available only as an upgrade to AMCAP Level 1.5.

## AMCAP 1.5 to AMCAP II upgrade \$995

(AMCAP is a trademark of American Intelligent Machines)

## OS-HDM Hard Disk Manager General

The Hard Disk Manager is an end user oriented software package designed to allow multiple independent systems to reside on the hard disk at the same time. Each system can contain over 150 program or file entries in its separate directory. Each system can be of any length from 600K bytes to several million bytes long.

Any AMCAP, DMS or other BASIC programs that operate under OS-65U can occupy any system area of any length within the Hard Disk Manager. Provisions are included to easily transfer an existing floppy based system to any system within the Hard Disk Manager.

## Fast Floppy Dumper

With the Fast Floppy Dumper back-up feature a user can easily and conveniently back up on removable floppies any or all systems (programs and files) residing on the hard with the standard hardware.

It takes approximately 1.3 minutes for each 250K of memory to automatically

be placed on a floppy diskette and the HDM automatically prompts when one floppy is full and another should be inserted.

## Cartridge Tape Back-Up

As with the Fast Floppy Dumper feature mentioned above, the OS-HDM package also contains a Cartridge Tape Back-Up feature. While this Cartridge Tape Back-Up is somewhat slower than the Fast Floppy Dumper it does not necessitate the operator inserting another floppy each time one becomes filled unless the size of a system on the hard disk exceeds the limit of the large capacity cartridge tape medium (approximately 11 megabytes). As with the Fast Floppy Dumper, the Cartridge Tape Back-Up is self-identifying and easily used by inexperienced personnel.

**OS-HDM \$675**

## OS-TMUM Timesharing Multi-User Manager

TMUM is a sophisticated and advanced software package that manages the timesharing features available with hard disk based C3 computers and offers the user true large computer timesharing capability with Log-On, Log-Off features, account number tracking, connect time usage by account number and system plus many other inherent timesharing system characteristics.

TMUM is designated to be used either in-house or with auto-answer modems and is thoroughly secure with non-echoing account number entry, system name, and classified password protection. The TMUM package is capable of accommodating up to 16 users and one console user depending upon machine configuration.

To accommodate a variety of different systems on the hard disk TMUM utilizes some of the multiple system techniques used with and explained in the Hard Disk Manager (HDM) package. This includes the ability to automatically back up any system of any size onto floppy diskettes. It also includes the ability to back up systems on the hard disk with the cartridge tape hardware now available.

The TMUM package is capable of running OS-AMCAP, DMS and all other programs including BASIC programs written in OS-65U.

OS-TMUM is available only as an upgrade to the Hard Disk Manager (HDM).

**OS-HDM to OS-TMUM upgrade \$1095**

## OS-DMS

The OS-DMS Nucleus and supporting business packages make up an extremely powerful Data Base Management System and Inquiry System that lend themselves to a wide range of small business applications. Generally, any collection of information of primary importance to a business can be placed in this system. To clarify the application of OS-DMS an explanation is necessary of a Data Base Management System and an Inquiry System.

Fundamentally, a data base is a collection of data. The data can be any information that is of value to a person, business or agency using the system. The data may be as varied as real estate files, inventories, personnel files, or automotive sales. Typically, data is usually kept in filing cabinets, card files, desk drawers, etc. Information in these categories are prime targets for a data base management system.

The operator has the ability to access the information of the data base in a manner which makes the data useful. The user has the ability to enter, remove, or edit information in the files to keep it current with present activities. The user also may change the order of information in a file to suit a particular application.

When the operator needs information, or a decision based on information in the file, a report of some kind will be generated.

The user, in some cases, may set specific conditions related to the report. Examples of conditions are inventory items over a certain amount, age analysis of accounts receivable or payable, or houses costing between two dollar amounts.

The emergence of OS-DMS makes computers immediately usable for the untrained small businessman. The system finally brings the use of micro-computers down to the level of non-programmers. It means that virtually untrained computer users can take advantage of the speed and efficiency of a computer in their daily activities.

## OS-DMS Modules

### OS-DMS Nucleus

OS-DMS Nucleus — provides the data base manager and information management system for DMS compatible files. Can be used to "computerize" any collection of information. Since it is written primarily in BASIC it can be easily customized for specific applications. It is also a useful maintenance tool to complement other DMS modules. **\$300**

DMS modules—specialized applications packages based on the OS-DMS information management system.

### OS-DMS — Inventory I and II

Inventory I is designed to be primarily a finished goods inventory for manufacturers, wholesalers and retailers. The system incorporates an inventory file, an order entry system, receiving program and shipping program. **\$300**

Inventory II is primarily a manufacturing inventory system which can be integrated with Purchasing system and Bills of Material system. These three packages collectively provide small manufacturing businesses with capabilities comparable to those found in MRP system, but with a higher degree of personal control. The Inventory system maintains an inventory with average weekly usage, weeks on hand, weeks on order with a shipping and receiving (or stock room control) program. **\$300**

### OS-DMS Purchasing System

The Purchasing System complements Inventory II by maintaining a file of open purchase orders and deliveries against those purchase orders. **\$300**

### OS-DMS Bills of Material

The Bills of Material System interfaces with Inventory II and the Purchasing System and will provide bills of material for several levels of subassemblies. This program maintains bills of material with cost accounting and allows the user to break down any assembly to its subsequent subassemblies, and ultimately to raw parts. This inventory explosion is highly useful for forecasting raw parts usage based on finished goods sales. It can also be used for inventory control applications to update raw parts and subassemblies inventories by the subassemblies and finished goods shipped out of a department. **\$300**

### OS-DMS A/R, A/P

Accounts Receivable and Accounts Payable system maintains accounts receivable and payables aging, detailed reports and customer statements. **\$300**

### OS-DMS General Ledger

DMS General Ledger System maintains a detailed general ledger based on a user specified chart of accounts. Also produces monthly statements including balance sheet and profit and loss statements. **\$300**

### OS-DMS Personnel Payroll

The Personnel Payroll system provides payrolls for a several hundred employee

company including check generation and quarterly reports. The Personnel Payroll system maintains detailed personnel files for each employee. It contains general purpose report writing capabilities which can generate a broad range of management requested reports. **\$300**

### OS-DMS Query

The Query System allows the computer operator to make queries about data stored in DMS compatible data bases. The result of this inquiry can be a simple answer or the generation of a report. Additionally the Query system allows end users to specify fairly complex report formats and store these report formats under user assigned names so that they can be recalled quickly for future use. DMS Query system effectively allows high-level utilization of the computer's resources by non-programmers. **\$300**

### OS-DMS Quotation Estimation

The Quotation Estimation package is useful for providing quotations and estimations on tasks which are comprised of many well defined and often used sub-tasks and components, such as those found in the construction industry. **\$300**

### OS-DMS Educational System

DMS Educational system allows teachers to generate drills, quizzes and tests without programming. The system allows several forms of student interaction. Grades and responses can be stored for teacher examination. Grades for an entire period can be automatically tabulated. **\$300**

### Customized Fully Integrated Systems

Customized fully integrated systems in the area of accounting, manufacturing, wholesaling, retailing and other services are available for multi-user timeshare and distributed processing based Ohio Scientific computer systems. These services are available through your local dealer as well as through the company's **Level 3 Support Group**. Contact your dealer for details.

### Specialty Applications

Dozens of specialized applications have been generated by Ohio Scientific dealers and systems houses under OS-DMS including fully integrated Construction packages, Medical Billing systems, Legal Billing systems and a broad range of specialized information systems. Contact your dealer for the latest information concerning your specific application.

# Ohio Scientific Systems for all reasons

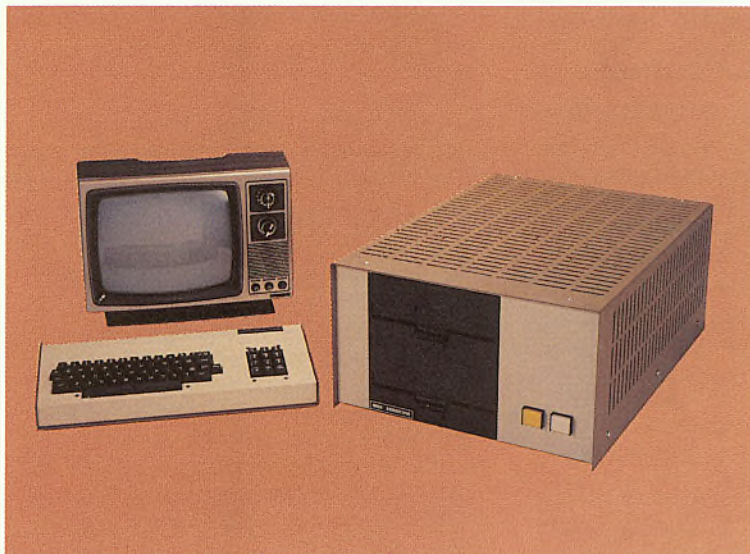

## Minimal System

<b>C2-OEM</b>	Complete 48K computer with OS-65D operating system and BASIC	<b>\$2,950</b>
<b>-02 Option</b>	Internal video instead of a CRT Terminal	<b>299</b>
<b>AC-3P</b>	12" TV monitor	<b>149</b>
	A complete low-cost dual 8" floppy computer which supports programs written in BASIC	<b>Total \$3,398</b>
<b>Option</b>		
<b>AC-19</b>	Low cost printer	<b>Add 699</b>
<b>CA-9</b>	Parallel Interface	<b>150</b>



## Accounting System

<b>C2-OEM</b>	Complete 48K computer with OS-65D operating system	<b>\$2,950</b>
<b>-05</b>	AMCAP complete small business accounting system (OS-65U + OS-AMCAP V1.5)	<b>775</b>
<b>AC-7B</b>	CRT terminal	<b>1095</b>
<b>AC-9TP</b>	Tractor-feed business printer	<b>1,450</b>
	<b>Basic accounting system</b>	<b>Total \$6,270</b>
<b>DSK-5A</b>	Desk	<b>Add 300</b>
<b>CA-17</b>	Networking capability	<b>Add 298</b>
<b>C3-OEM</b>	3-processor system (twice as fast as C2-OEM)	
	C3-OEM-06 instead of C2-OEM-05	<b>Add 1,045</b>
<b>-07 Option</b>	CP/M with FORTRAN and COBOL on C3-OEM	<b>Add 400</b>

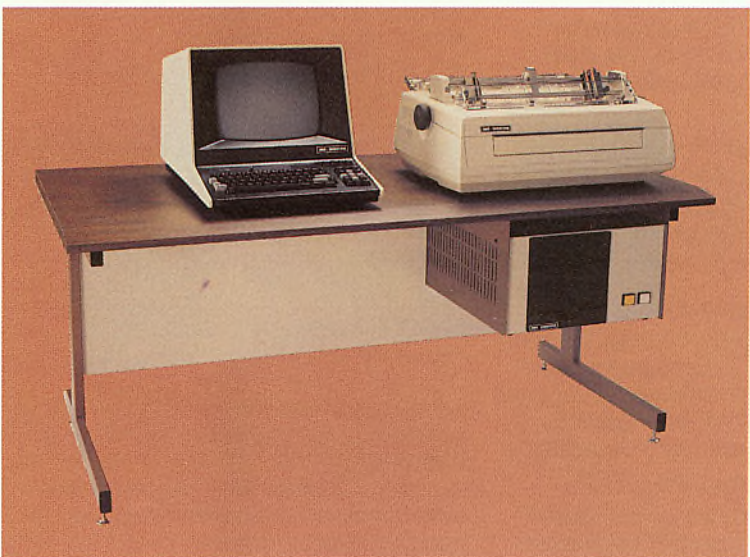

## Deluxe C3 Accounting System with BASIC/ FORTRAN/ COBOL and Network Communications

**\$8,313**

## Word Processing System

<b>C2-OEM</b>	Complete 48K computer	<b>\$2,950</b>
<b>WP-3-2</b>	Word Processing software	<b>300</b>
<b>AC-7B</b>	CRT terminal with upper/lower case	<b>1095</b>
<b>AC-14A</b>	Word Processing Printer	<b>1,995</b>
<b>DSK-5A</b>	Matching Desk	<b>300</b>
	<b>Total Word Processing system</b>	<b>\$6,640</b>

Note, the Word Processing system can be upgraded to Networking, C3 system, AMCAP Accounting and CP/M as per the example above.



# Typical Configurations

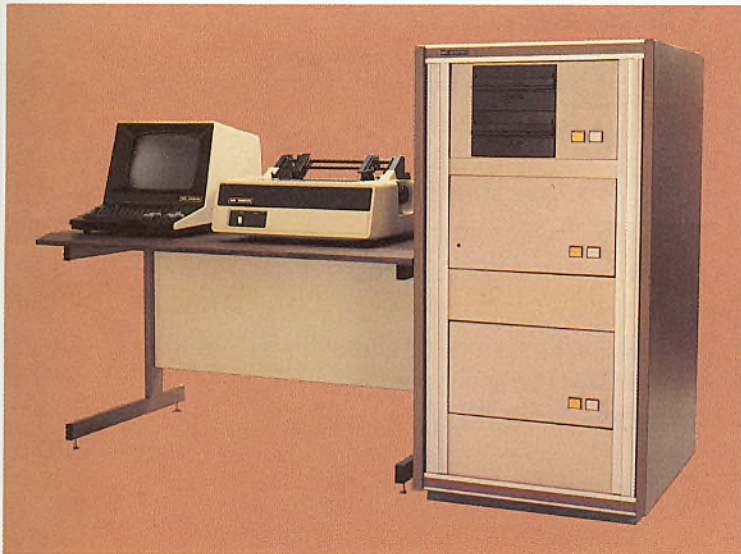

## Minimal Hard Disk System

<b>C3-C</b>	23 megabyte C3 computer with OS-65U	<b>\$10,995</b>
<b>AC-7B</b>	CRT terminal	<b>1,095</b>
<b>AC-9TP</b>	Tractor-feed business printer	<b>1,450</b>
<b>Total Subsystem Cost</b>		<b>\$13,540</b>
<b>DSK-5</b>	Desk	<b>Add 250</b>
<b>DMS</b>	Nucleus for mailing lists, customer lists, subscribers, supporters, etc., specific DMS modules for inventory, order entry, customers, personnel, etc.	<b>Add Per Module 300</b>



## Large Capacity Accounting System

A deluxe standardized accounting system for small to medium-size companies.

<b>C3-C</b>	52K static RAM 3-processor .7 MIPS CPU with dual floppies and 23 Mbyte hard disk directly expandable to timesharing	<b>\$10,995</b>
<b>AC-7B</b>	CRT terminal	<b>1,095</b>
<b>AC-5A</b>	Deluxe 160 LPM business printer	<b>3,350</b>
<b>OS-HDM</b>	Hard Disk Management and Fast Floppy Dumper	<b>675</b>
<b>OS-AMCAP V1.5</b>	Complete small business accounting system (the 23 Mbytes can easily handle all the accounting files of a 10M a year business or larger) -06 option on C3s.	<b>775</b>
<b>Total</b>		<b>\$16,890</b>
<b>DSK-6</b>	Desk	<b>Add 285</b>

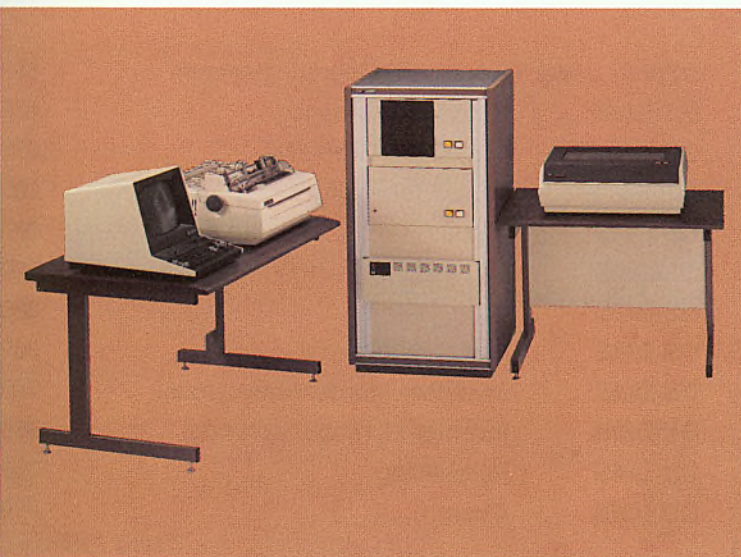

## The Complete Office Friday

With an ultra-fast CD-74 hard disk for further expansion, complete word processing, information management, general accounting, inventory and order entry software.

<b>C3-B</b>	74 megabyte disk based C3 computer	<b>\$13,995</b>
<b>AC-7B</b>	CRT terminal	<b>1,095</b>
<b>AC-5A</b>	High speed deluxe business printer	<b>3,350</b>
<b>AC-14B</b>	Word processing printer	<b>2,795</b>
<b>DSK-3</b>	Desk	<b>175</b>
<b>DSK-6</b>	Desk	<b>285</b>
<b>WP-3</b>	Word Processor	<b>300</b>
<b>OS-DMS (Nucleus) Information Manager</b>		<b>300</b>
<b>OS-DMS A/R A/P</b>		<b>300</b>
<b>OS-DMS G/L</b>		<b>300</b>
<b>OS-DMS Personnel/Payroll</b>		<b>300</b>
<b>OS-DMS Inventory I</b>		<b>300</b>
<b>OS-DMS Query</b>		<b>300</b>
<b>Total</b>		<b>\$23,795</b>

# Ohio Scientific Systems for all reasons

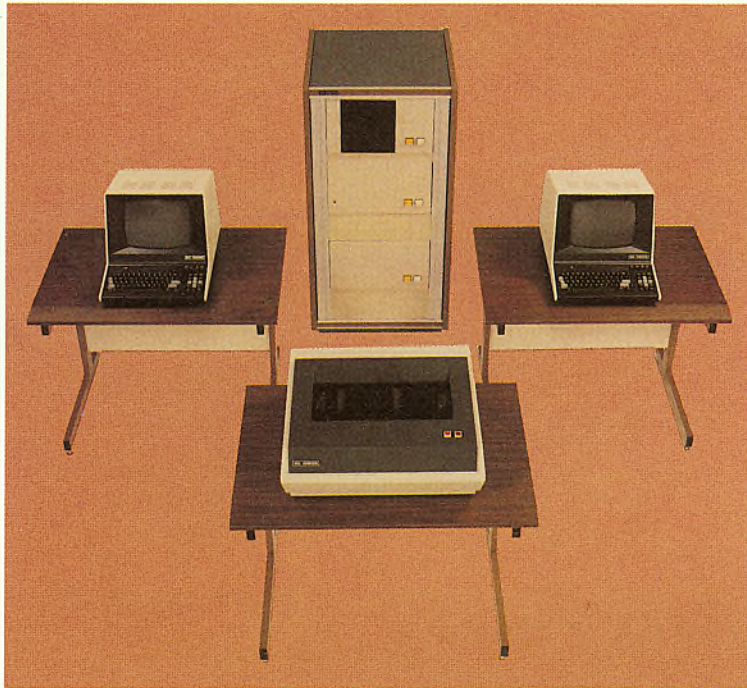

## A 2-user System

Maintain order entry, order checking, and inventory control while performing general accounting and payroll.

<b>C3-C-22</b>	2-user C3-C with .7 MIPS operation and 23 megabyte disk	<b>\$12,400</b>
<b>(2) AC-7B</b>	CRT terminals	<b>2,190</b>
<b>AC-5A</b>	160 LPM business printer	<b>3,350</b>
	<b>Subtotal</b>	<b>\$17,940</b>

<b>OS-AMCAP</b>	(-06 option on C3s)	<b>775</b>
<b>OS-HDM</b>	Hard Disk Manager	<b>675</b>
	<b>Total</b>	<b>\$19,390</b>

## A Timeshare Business System (4-user)

A Timeshare Business Accounting System with Data Base Manager, Information System, Highly Adaptive Accounting Modules and Word Processor Capabilities.



## General Specifications:

4 terminals, 200Kbytes RAM, dual floppies, 74 Mbytes ultra-fast access hard disk, .7 MIPS operation throughout.

<b>C3-B-44</b>	4-user C3-B with 200K RAM, 74 megabyte disk	<b>\$17,400</b>
<b>(4) AC-7B</b>	CRT terminals	<b>4,380</b>
<b>AC-5A</b>	Deluxe 160 LPM printer	<b>3,350</b>
<b>AC-14B</b>	Word Processing printer	<b>2,795</b>
	<b>Subtotal</b>	<b>\$27,925</b>

<b>OS-65U Level 3</b>	Timeshare Operating system	<b>500</b>
<b>OS-HDM</b>	Hard Disk Manager	<b>675</b>
<b>OS-TMUM</b>	Timeshare Executive	<b>1,095</b>
<b>WP-3-2</b>	Word Processing System	<b>300</b>
<b>OS-DMS</b>	Nucleus	<b>300</b>
<b>OS-DMS</b>	A/R, A/P	<b>300</b>
<b>OS-DMS</b>	G/L	<b>300</b>
<b>OS-DMS</b>	Personnel/Payroll	<b>300</b>
<b>OS-DMS</b>	Inventory I (order entry/stock)	<b>300</b>
<b>OS-DMS</b>	Inventory II (manufacturing)	<b>300</b>
<b>OS-DMS</b>	Purchasing	<b>300</b>
<b>OS-DMS</b>	Query	<b>300</b>
	<b>Total</b>	<b>\$32,895</b>

# Multiple Users

## Networked Systems: The Office of the Future

Each function has its own processor which utilizes shared data bases and peripherals. The tremendous collective CPU power accommodates highly sophisticated yet fast and easy to use software which is both self-adaptive and easy to modify manually.

## General Specifications:

A two data base ten terminal system. Each terminal supports general information processing, accounting, word processing, and program development. The system collectively features 4.2 MIPS, 624K RAM, and 148 Mbytes of on-line hard disk storage. Because floppy based intelligent terminals were selected, each user can operate stand-alone and 5 users can be networked if one data base fails providing a high degree of ability to stay "up" at reduced throughput capacity during equipment failures.

## Data Bases

(2) C3-B-N1	74 Mbyte, C3 computer (.7 MIPS CPU configured for networking) with 104K total (all 300 NS memory), 1 net port and 4 intelligent terminal ports	<b>\$31,990</b>
AC-14B	Word Processing printer to be installed on one data base	<b>2,795</b>
AC-5A	Deluxe 160 LPM business printer to be installed on the other data base	<b>3,350</b>
(2) AC-7B	Console terminals support normal end user operation as well as control functions	<b>2,190</b>
	<b>Subtotal</b>	<b>\$40,325</b>

## Intelligent Terminals

(Any Ohio Scientific BUS oriented computer can be used by expansion to 56K and a cluster communications port)

(8) C2-OEM	48K dual floppies, .35 MIPSCPU	<b>23,600</b>
(8) CA-17	Memory and Network Ports	<b>2,384</b>
(8) AC-7B	CRT terminals	<b>8,760</b>
	<b>Subtotal</b>	<b>\$34,744</b>

## Software

Level3 Network Site License	<b>995</b>
Approximately 10 Network compatible DMS modules as desired	<b>3,000</b>

**Total base price not including installation and software customization \$79,064**

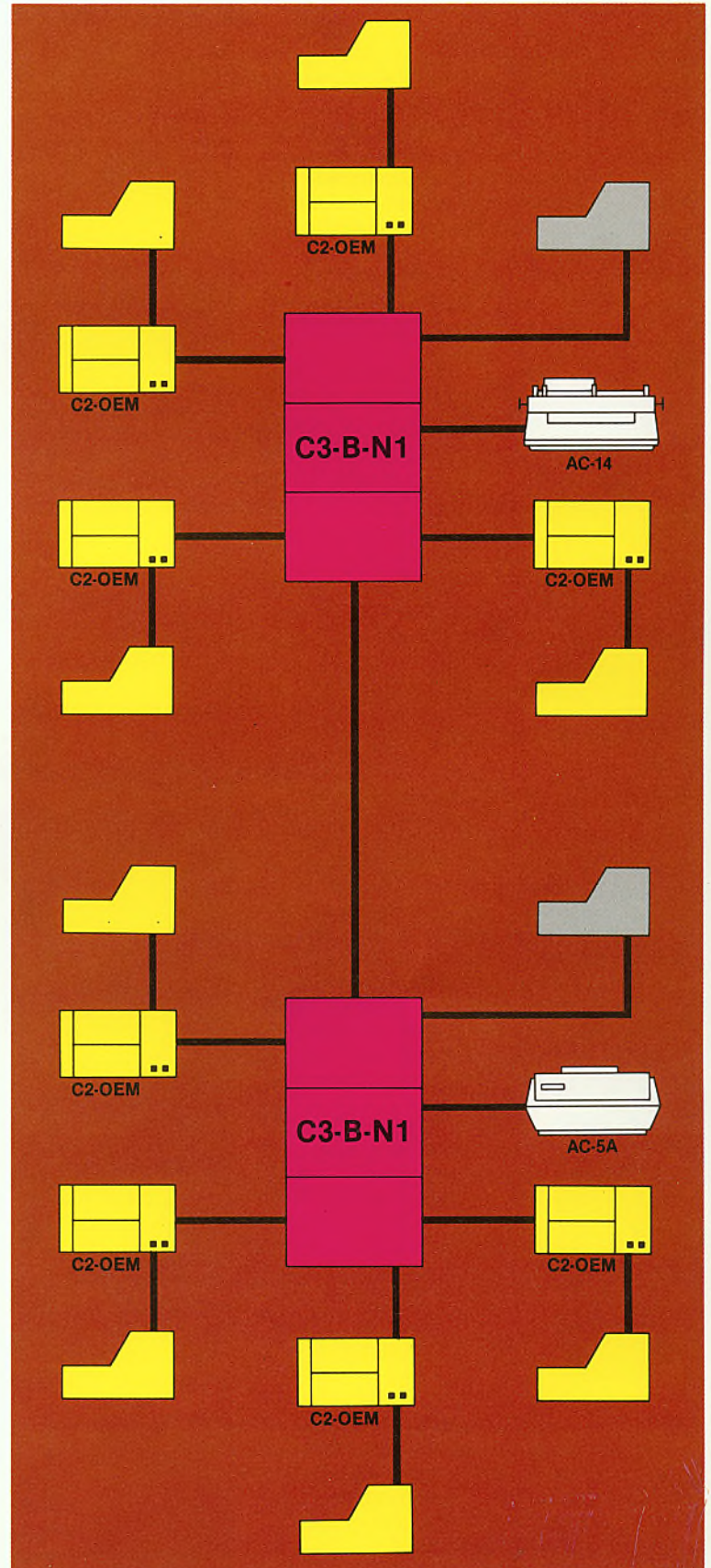

# Ohio Scientific Accessories for all reasons

## Ohio Scientific's Revolutionary New 16 Pin I/O BUS

Modern technology has made it possible to pack far more I/O functions on a computer board than one can practically connect to. Ohio Scientific has solved this problem with a series of remote "head end cards" which feature tremendous I/O capability and connect to the computer via single inexpensive 16 pin DIP ribbon cables. Thus I/O connection can be made away from the computer's card cage.

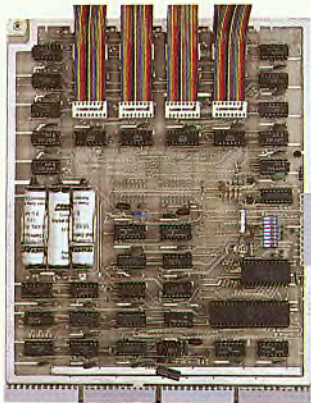

**CA-20**  
8-port I/O BUS interface and calendar clock provides interfaces for 8 head end cards and a battery back up clock with hours, minutes, seconds, 1/10 second, day, and date. The automatically re-charged batteries will power the clock for months. **\$175**

**CA-20A**  
As above without clock **\$95**

## Head End Cards

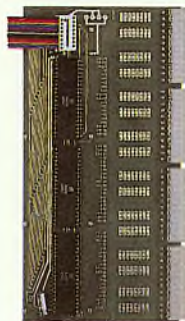

**CA-21**  
48 Line Parallel I/O card features 3 PIA's and prototyping area **\$45**

16 pin BUS family boards should be powered by external means where possible, however, a few modules can be supported by the host computer's supply if necessary.

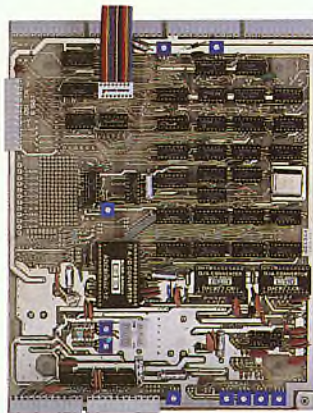

**CA-22**  
High speed analog I/O module. Two 12-bit D/A converters, 1 12-bit/8-bit A/D converter with 16 channel input multiplexer. Factory configured for  $\pm 10V$  offset binary, user jumperable for other configurations. Max error  $\pm 2$  LSB. 28,000 12-bit conversions per second. 66,000 8-bit conversions per second, drift. -50 ppm per  $^{\circ}C$ . Note, the CA-22 can also be directly plugged into the computer without a CA-20, thus occupying one slot. **\$598**

**CA-23**  
PROM Blaster. Programs 2758, 2716, 2732 and 2764. 8 through 65K EPROMS. Programs and verifies from memory or other EPROM. **\$195**

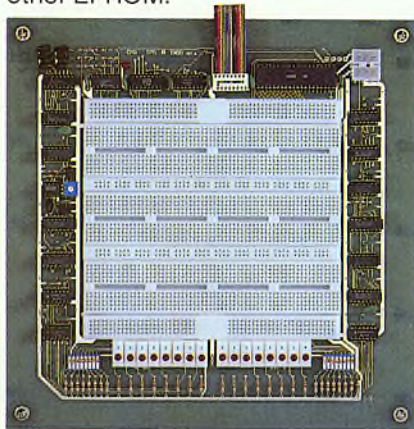

**CA-24**  
Solderless interface prototyping board features a PIA and TTL I/O as well as provisions for direct user connection of devices such as the 6850 ACIA. Board also features 16 switches and 16 LED's. Has a large solderless breadboard for prototyping or educational lab exercises. **\$175**



**CA-25**  
Security and AC remote interface connects the AC-17P home security system and AC-12P wireless remote control system to C2 and C3 computers. **\$45**

## AC-17P



A home security system, that's wireless and includes a control console, a fire detector, two window protection devices and one door unit. Additional protection devices are commercially available. **\$249**

## AC-12P



Wireless AC remote control. AC Remote Control Starter Set includes control console and modules to operate two lamps and two appliances via remote control with home control software on disk. Additional appliance and lamp modules are commercially available. **\$175**

## Process Control BASIC

A modified 9-digit BASIC under 65D with commands that support the real time clock, time of day clock (CA-20), 48 line parallel I/O (CA-21) analog I/O model (CA-22), AC remote (AC-12P) and to a limited extent the UTI (AC-15V) and security system (AC-17P). **TBA**

**Security BASIC** — Use your computer for business accounting during the day and office and plant security at night!

A modified BASIC under 65D with commands which support the real time clock, AC-remote (AC-12P), security system (AC-17P) and universal telephone interface (AC-15V). Comes complete with a library of security program demonstrations. **TBA**

# OEM and R/D Accessories

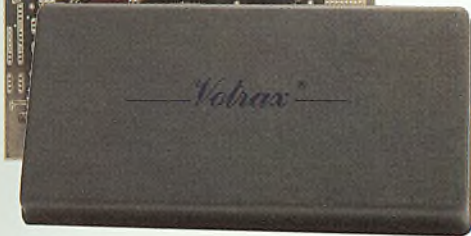
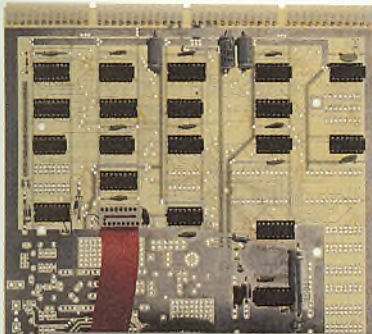

## CA-14A Votrax Voice I/O System

This Votrax Voice Synthesizer module has the capability of generating English speech phonetically. The supporting software simply feeds the phonetic spelling of English words to the module which generates medium quality spoken words. This advanced Votrax system is capable of generating all English phonemes as well as four levels of inflection on each phoneme. CA-14A also includes a voice recognition experimentation area which must be user populated. This experimentation board contains a five filter feature extractor with zero crossing detectors and envelope filters. The CA-14A in conjunction with the CA-22 high speed analog I/O module provide a complete voice recognition lab. **\$399**

## Voice Output Software

### OS-Vocalizer I

"Generation by Rules System". Runs under OS-65D or OS-65U. Accepts conventional English spelling and outputs the phonetic spelling to the Votrax module in real time. Also, will print phonetic spellings for use by other programs. **\$150**

### OS-Vocalizer II

Runs in one partition of a 65U Level 3 system. Accepts normal print statements from other partitions (users) and vocalizes them in real time. Uses disk look up for the 3000 most common words and generation by rules for words not on file. End user can add approximately 1500 additional words to file. Generates the most legible speech now attainable via totally synthetic means (i.e. not recorded human speech). Operates on a C3-B or C3-C with at least two partitions. **\$975**

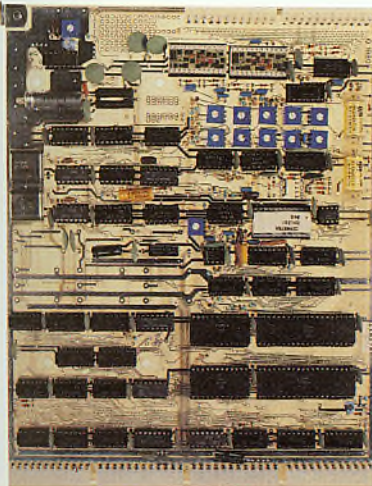

## CA-15 Universal Telephone Interface

The Universal Telephone Interface provides the host computer with general purpose telephone communications capability. The board can answer and originate calls. It can communicate with internal 300 baud modem in originate or answer back mode. It can also communicate with touch-tone and decode touch-tone. The board also has multiplexers to route spoken voice out to external devices such as recorders, voice recognition circuits, A/D converters and can accept spoken voice from several sources to dispatch to the telephone. The UTI can be used with touch-tone or rotary dial lines via its pulse code dialer. When equipped with a Votrax module or used in conjunction with a CA-14 voice I/O, it can respond with computer generated English voice output. The UTI is connected to telephone lines via a CBT. CBT's can be rented along with the telephone lines from your local telephone company or can be purchased from your local dealer and connected in parallel with your existing telephone circuitry. **\$499**

## UTI with Votrax CA-15B

The Universal Telephone Interface as above with Votrax Voice module allows your computer to generate English speech phonetically. It also includes an audio amplifier to allow the Votrax module to be used stand alone independently of the telephone lines. **\$799**

## CA-CBT

FCC approved telephone line isolator for use with the UTI. It allows the UTI to connect to any conventional telephone line. Note. CBT's can also be leased from your telephone company along with the telephone line. **\$199**



# Ohio Scientific Microcomputer Specifications

Standard Features	C2-OEM	C2-D	C3-OEM	C3-D	C3-A	C3-B	C3-C	C3-BN1	C3-BN4	C3-B44	C3-B18
CPU	6502	6502	6502A Z80A 68B00	6502A Z80A 68B00	6502A Z80A 68B00	6502A Z80A 68B00	6502A Z80A 68B00	6502A Z80A 68B00	6502A Z80A 68B00	6502A Z80A 68B00	6502A Z80A 68B00
6502 CPU Speed in MIPS	.35	.35	.7	.7	.7	.7	.7	.7	.7	.7	.35
RAM	48K	48K	48K	48K	48K	52K	52K	104K	248K	200K	392K
RS-232 Ports	1	1	1	1	1	1	1	2	5	4	8
Floppy Disk Storage	600K	300K	600K	300K	600K	600K	600K	600K	600K	600K	600K
Hard Disk Storage	—	7M	NR	7M	AV	74M	23M	74M	74M	74M	74M
OS-65D Operating System	STD	STD	STD	STD	STD	STD	STD	STD	STD	STD	STD
OS-65U Operating System	STD	STD	STD	STD	STD	STD	STD	STD	STD	STD	STD
Total BUS Slots	8	8	8	8	17	17	17	17	17	17	17
Open Slots for Expansion	6	3	3	2	12	10	10	5	1	3	1
Power Supply Capacity in Amps (5 volts) - 9v., 1a./ +12v., 1a.	5	8	8	8	16	16	16	16	40	40	40
Case Size (in inches)	12 x17 x22	12 x17 x15	12 x17 x22	12 x17 x15	54 x24 x26	54 x24 x26	54 x24 x26	54 x24 x26	54 x24 x26	54 x24 x26	54 x24 x26
Power Requirements at 110 volts AC, 60 Hz	4	8	4	8	6	12	10	12	15	15	15
<b>Options</b>											
GT Option	—	—	AV	AV	AV	AV	AV	AV	AV	AV	—
Double Sided Disk Option	AV	AV	AV	AV	AV	AV	AV	AV	AV	AV	AV
Expansion to Network (Station)	AV	NR	AV	NR	AV	NR	NR	NR	NR	NR	NR
Expansion to Multi-User (Timeshare)	—	—	NR	NR	AV	AV	AV	STD	STD	STD	STD
Expansion to Network Database	—	—	—	NR	AV	AV	AV	STD	STD	AV	AV
OS-CP/M Compatible (Extra memory required is specified.)	—	—	yes + 8K	yes + 4K	yes + 8K	yes + 4K	yes + 4K	yes	yes	yes	yes
WP-3 compatible	yes	yes	yes	yes	yes	yes	yes	yes	yes	yes	yes
OS-AMCAP Compatible	yes	yes	yes	yes	yes	yes	yes	yes	yes	yes	yes
OS-DMS Compatible	yes	yes	yes	yes	yes	yes	yes	yes	yes	yes	yes

**Key:**

AV — Available  
 — — Not Available  
 NR — Possible but not recommended  
 STD — Comes equipped with this  
 standard feature

**Note:**

The C-3 BN1, N4, 44 and 18 are examples of  
 Level 3 group custom systems the same specs hold for  
 C3-C versions except that disk storage capacity is 23M not 74M.

(Prices and specs subject to change without notice)

# Selecting and Configuring Systems

This brochure is an aid to selecting and configuring your system; however, it is not a substitute for discussing your specific applications and requirements with your local Ohio Scientific dealer before selecting a system.

## General Support:

Learning how to use your Ohio Scientific system's capability is critically important in making your purchase a success. Years of experience in professional systems installation have shown that although manuals are a useful aid to getting started, there is no substitute for guided hands-on training. Once your operators and/or programmers are comfortable with the fundamentals, the manuals provided with the systems and software can be used to expand their capabilities and provide a handy reference.

Ohio Scientific dealers offer group seminars and individualized training in operating, programming, and managing Ohio Scientific computers. Additionally, Ohio Scientific is now offering high level factory seminars on our computers and software. These seminars are scheduled on a basis of frequency of customer request. Ohio Scientific has started and is rapidly expanding a series of VHS® format video training cassettes on computer systems and applications software use by operators and managers.

## Software Maintenance and Customization:

Ohio Scientific dealers offer customization services on a hourly or job basis. All standard factory software is sold on a one copy as-is basis. Ohio Scientific now offers a subscription update service on major software packages directly with end users. This service is available on a modest yearly fee basis. It provides the end user with a direct factory contact and the assurance of getting the latest version of each software package as soon as it is available.

Additionally, Ohio Scientific's Level 3 support group is available to configure, modify and customize multi-user and distributed processing applications software and systems on an hourly and/or job contract rate.

## Hardware Support:

It is important to recognize the importance of computer servicing in your specific application and to choose the most cost effective plan compatible with your requirements. Ohio Scientific computers are built from easy to service

modular components. The actual cost (parts and labor) to repair a malfunction has historically been very low. Over the last three years the average factory repair billing is under \$40.00. Fast on-site maintenance is far more costly (\$200 to \$400 per visit) because of the travel expense, test equipment maintenance expense and the cost of keeping spare parts and a trained technician on stand-by in anticipation of service calls.

Ohio Scientific users have three general maintenance options:

**On-Site Service Contracts:** Many Ohio Scientific dealers and independent third-party service companies offer on-site maintenance contracts on a yearly basis. Typical response time is next day and typical charges are 1 to 1.5% of the systems original cost per month.

**Depot Repair Service:** Many Ohio Scientific dealers offer inexpensive depot repair service. This type of service is practical on the easy-to-handle double case C2-OEM-04 and C3-S1, particularly if the user has more than one computer on-site, so that critical tasks can be shifted to the other computer during repairs.

**Customer Sponsored Maintenance:** OEM users and upper level educational users typically have personnel capable of electronic repairs. Ohio Scientific is the first company to have all its computers documented by Howard Sams, Inc. (The originators of the SAMS photofact series for consumer electronic repair.) Ohio Scientific and many dealers maintain repair parts inventory. Additionally, spare kits are available for on-site backup.

## Total Cost of Installation

The prices in this brochure are the factory recommended 1-4 quantity OEM price. Business end users in particular will want to obtain additional services from their dealer, based on the level of support they require. The additional possible costs to complete the entire system installation are listed here. Some computer companies claim to include some of these costs in the system price but this practice frequently yields inflated prices and/or over-looked support obligations.

The Ohio Scientific pay-as-you-go philosophy ensures you that you will pay *only* for the support you need and that you will get all the support you pay for. This approach yields the lowest possible total cost of installation and ownership.

1. Computer hardware and software package cost (from this brochure).
2. Dealer preparation and on-site installation—The C2, C3-OEM computers can be plugged in and running a few seconds after the box is open. Hard disk computers come in four boxes and must be installed in their racks. Furniture is shipped broken down and must be assembled. Accessories must be plugged in, bolted down and tested. Generally, installation labor will run from \$25 to \$35 per hour and take one to two days per computer system, depending upon system complexity (\$200 to \$600).
3. Training—Each operator should receive one to two hours of general computer operation training. Each business operator should receive "simulation" training under the software system he/she will be using. For example, a general ledger clerk should post a small hypothetical set of books for a "work" month to balance sheet and P/L statement before operating with real data. Word processing operators should generate a few letters under an instructor's direction, etc. Such training can range to 20 hours depending on the task complexity. Training costs will range from \$25 to \$35 per instructor hour.
4. Software configuration—Ohio Scientific business systems have built-in configuration features. These configuration programs set up charts of accounts, receivable/payable files, inventory files, etc., for your specific application. Although these programs are designed for the end user, a little expert assistance at configuration time can save aggravation and "false starts". Such assistance should cost a maximum of \$200-\$300.
5. Software customization—The software packages in this brochure are general-purpose systems (with self-configuration programs) designed to be usable by a broad range of business *without* customization. Customization is very expensive. Carefully study the capability of standard packages before you decide you need customized software. In many cases you will find that the standard software really can do the job with a minor modification in your procedures.

In any case, review all details of installation with your dealer before you purchase, so that you will be assured of getting the services you require without placing unreasonable demands upon your dealer. For the name of the dealer nearest you, **CALL 1-800-321-6850 TOLL FREE.**

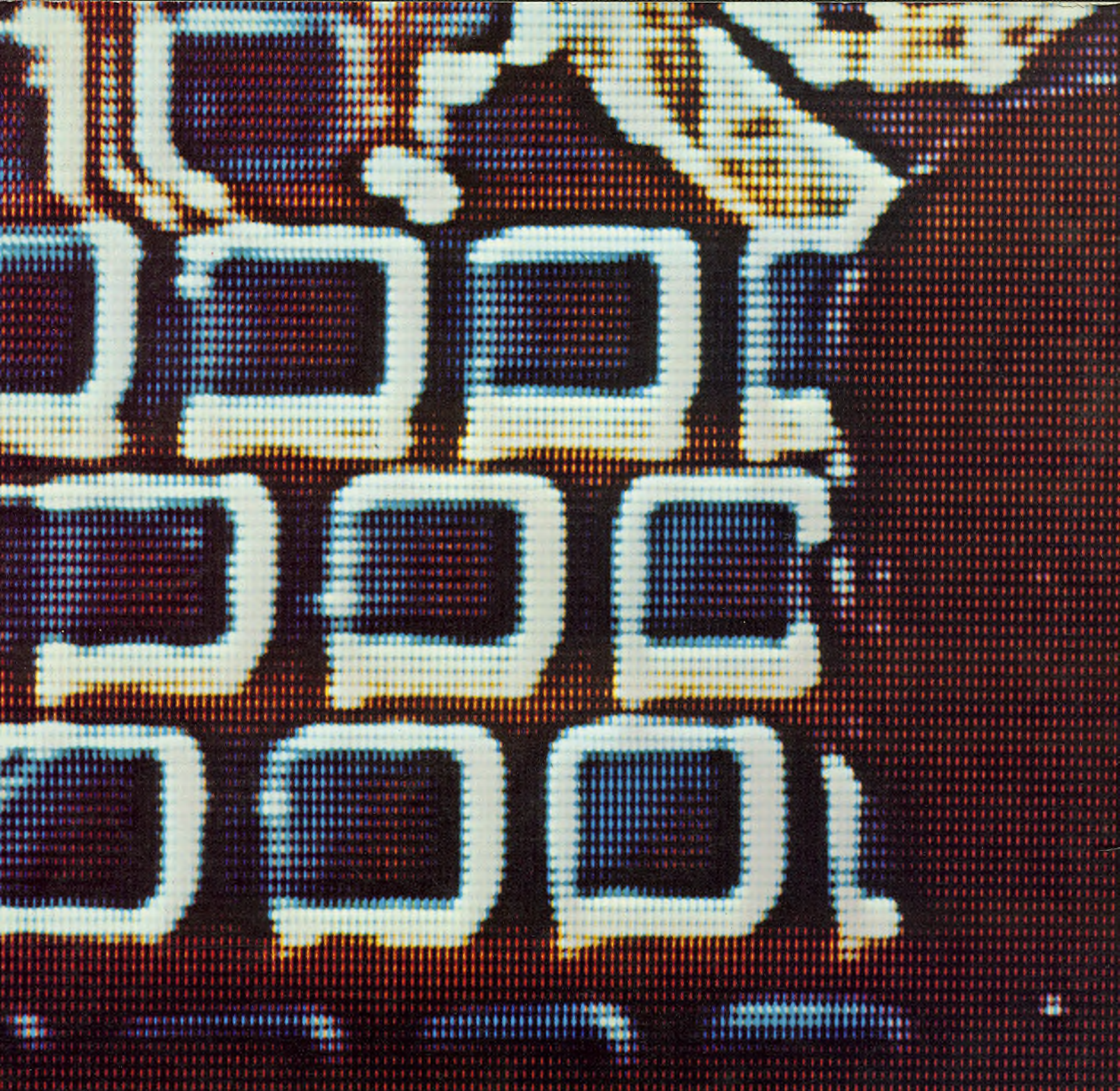

## **OHIO SCIENTIFIC**

1333 SOUTH CHILLICOTHE ROAD  
AURORA, OH 44202 • (216) 831-5600

**CALL 1-800-321-6850 TOLL FREE**